



VAN CARE



XLD_LINE

CATALOGUE 2023

TABLE OF CONTENTS

PAGE

ABOUT US.....1

XLD_LINE.....7

TECHNICAL DATA.....18

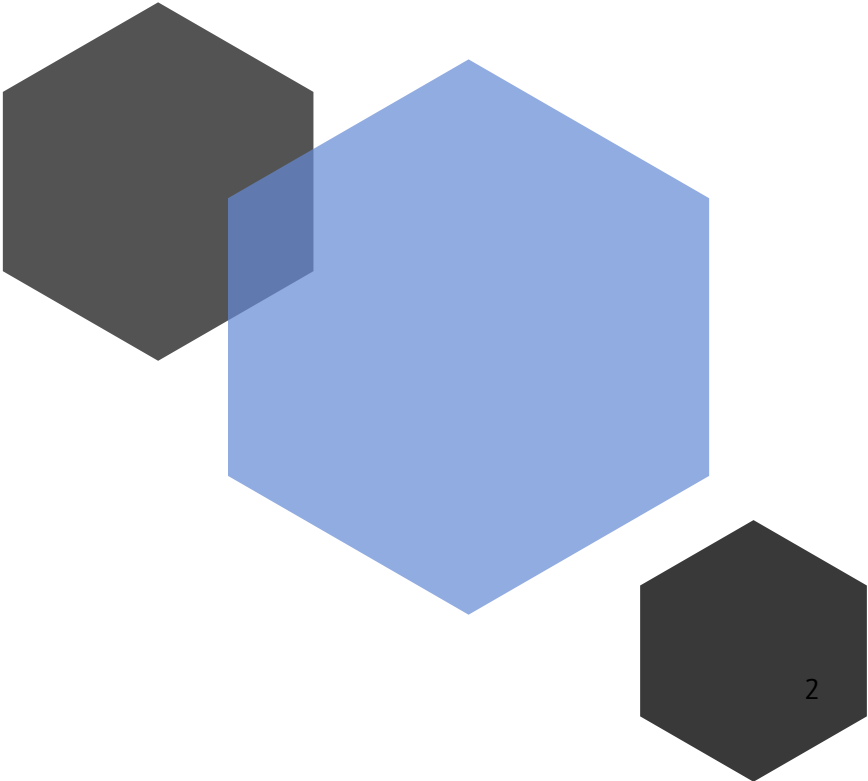

OUR OFFER

VAN RACKING SYSTEMS



ABOUT US

Van Care has been a manufacturer in the field of commercial vehicle Van Racking Kits for many years. The production site is based in Poland, and has 100 employees.

VAN CARE OFFERS SOLUTIONS FOR EVERY TYPE OF COMMERCIAL VEHICLE.

We work with lightweight modular equipment and provide tailor-made solutions. The modular construction allows you to put together your ideal interior with the exact shelves, drawers and spaces you need.

Thanks to an extensive network of specialized dealers, we can deliver fully customized Van Racking.

Kits tailored specifically to your needs. Feel free to contact us for more information and an introductory conversation.

VAN CARE PRODUCTS

Van Care products are innovative, lightweight and durable. All products are made of ultra-high strength materials, resulting in minimal weight and maximum loading capacity.



THE BEST
QUALITY

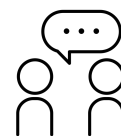

FREE
CONSULTANCY



COST
REDUCTION

SAFETY

All Van Care's Van Racking Kits are tested extensively. Crash tests are continuously being carried out at specialized research centers.

Simulation, load capacity and vibration tests are continuously researched and performed.

Time and time again our products have proven to be extremely safe. Take these results from one of our frontal impact tests for example.



The speed of the crash test was increased from 32km/h to 50km/h. According to the report, the material had been deformed, but without creating dangerous situations for the passengers due to the loosening of parts.

PROVEN QUALITY OF OUR PRODUCTS

Van Care guarantees optimal safety, today and in the future. Everything is made for functional use and safety during work and transport. The production is fully certified and complies to ISO 9001:2015 and TÜV requirements.

SAFETY & QUALITY

ARE OUR MAIN GOALS

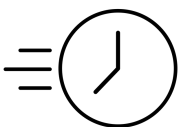

TIME
SAVING



PERSONALIZED
PROJECTS



GREAT
TESTS RESULTS



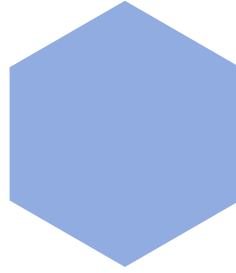



**WE ADVISE,
DESIGN,
PRODUCE.**

At Van Care, we realize the importance of a properly designed interior. Therefore, we place great emphasis on customer needs research and consultations. Adding to this many years of experience, we are able to design a car interior that will meet the expectations of even the most demanding customers. Customer satisfaction is our top priority.

Say what you expect and we will help you to achieve it.

XLD_LINE

In addition to our standard shelves, cabinets and other convenient storage systems from M_line, Van Care also offers the XLD line - large, strong, yet light drawers.

VAN CARE PRODUCTS - XLD_LINE

This new, innovative product is made of lightweight but highly durable materials. It allows for a very large cargo space. Whether you are looking for a double floor with access to sturdy drawers or you want to use a load space with light and functional drawers, XLD_line combines both in one product. It is the perfect solution for any vans, regardless of its size.

ROBUST AND LIGHT

XLD drawers are robust, strong, but at the same time light in XL size that run on telescopic ball slides. Each drawer has a load capacity of up to 85 kg (surface load). The frames provide a rigid and solid structure, while increasing the load capacity of the vehicle.

PERFECT QUALITY-TO-WEIGHT RATIO

Thanks to the intelligent use of high-quality steel and aluminum, and an innovative design, we have achieved the ideal strength-to-weight ratio for our XLD-line. All products are powder coated, and the ceramic layer used makes them scratch resistant.



DRAWERS FOR SPECIAL TASKS

DESIGN ACCORDING TO YOUR NEEDS

The modular construction of the XLD-line allows for a very wide range of possibilities and the adjustment of the space to the needs of the vehicle user. Drawers can be installed under the floor or as column-mounted in the utility part of the car.



USE WITHOUT LIMITATIONS

The drawers open 100%, which allows you to make the most of the loading space. An additional advantage is the access to the drawers from the outside, thanks to which they can be used freely and give unlimited access to the products and tools necessary for work. The load capacity of the divided surface of the flat drawer is 80 kg, thanks to which it can be used to store even the heaviest equipment.

ONE PRODUCT, MANY POSSIBILITIES!

4 lengths
L1/L2/L3/L4

4 heights
HL1/H1/HL2/H2

3 widths
W1/W2/W3

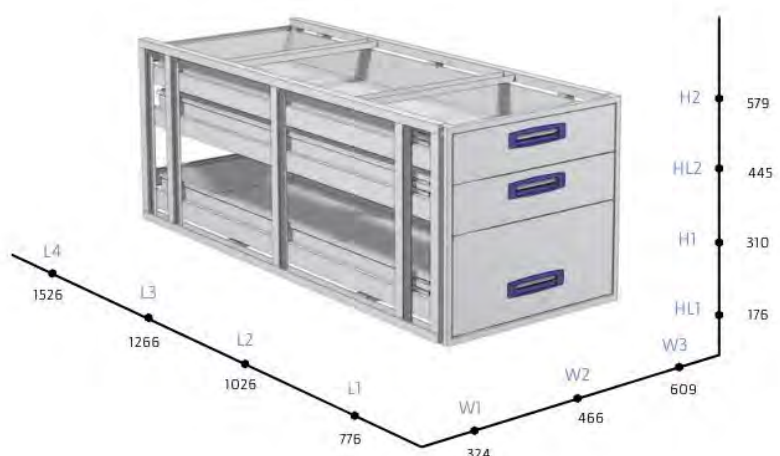

SPECIFICATION OF XLD DRAWERS



XLD-L3W1H1-1

16-0-003-00
XL Frame with one drawer
1266x346x310
weight: 25 kg

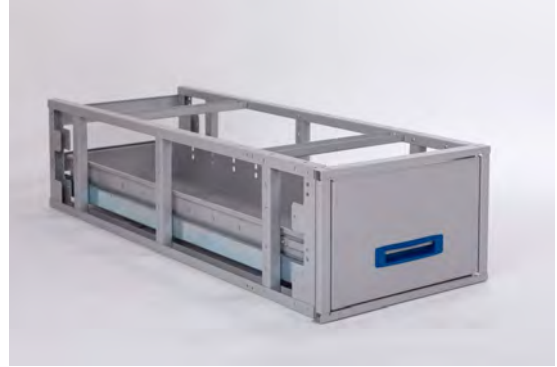

XLD-L3W2H1-1

16-0-173-00
XL Frame with one drawer
1266x488x310
weight: 27 kg



XLD-L3W3H1-2

16-0-032-00
XL Frame with two drawers
1266x631x310
weight: 42 kg



XLD-L2W1H2-2

16-0-007-00
XL Frame with two drawers
1026x346x578
weight: 36 kg



XLD-L2W3H2-3

16-0-036-00
XL Frame with three drawers
1026x631x578
weight: 54 kg



XLD-L1W2H2-4

16-0-028-00
XL Frame with four drawers
776x488x578
weight: 50 kg

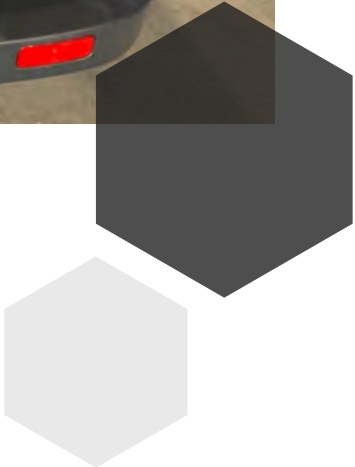





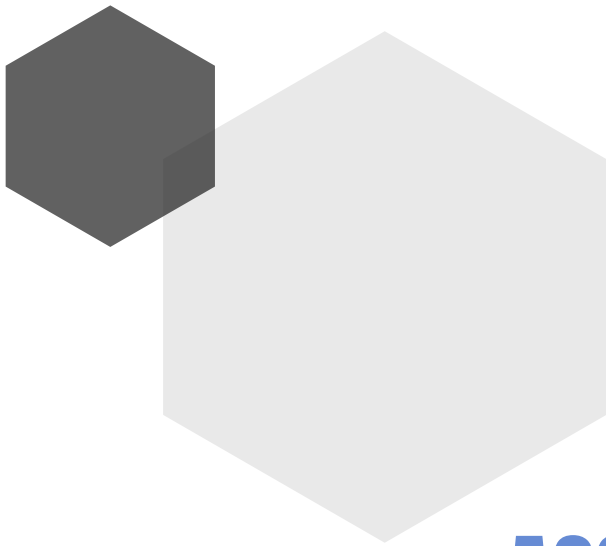

ACCESSORIES

Choosing the right van racking modules is only half the battle. Very good organization of the workplace, those are primarily accessories. Containers, suitcases, handles with various functions make the space take on a completely new character, and most importantly, they secure the items necessary for work and organize the space.

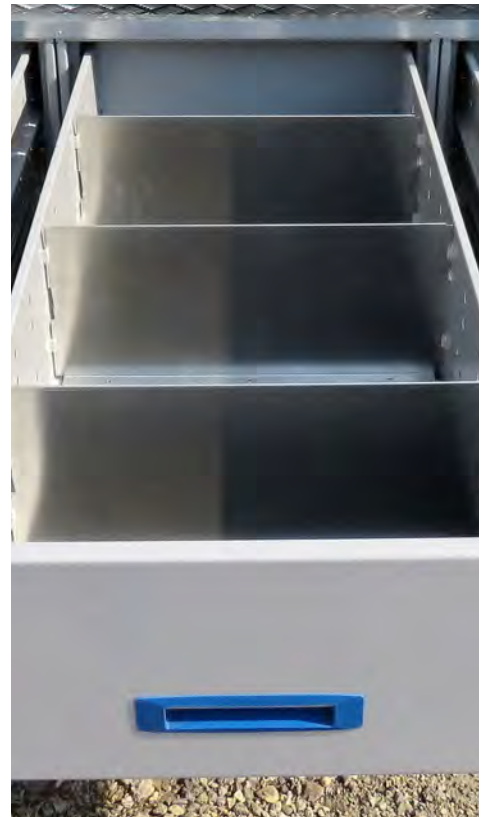



15

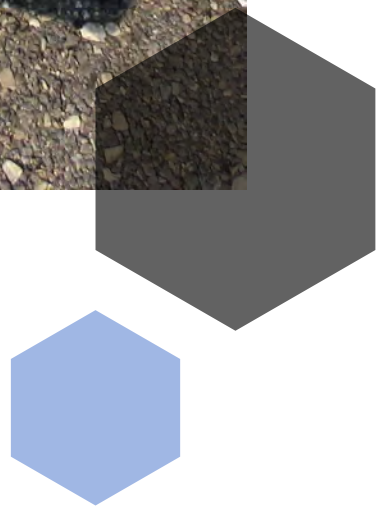



TECHNICAL DATA

XLD Drawers and accessories.

Van-Care XLD Drawer range opening 100%



General information about Van-Care's XLD Drawer.

Regular XLD drawers come in 4 depths and 3 widths.

The 4 standard system depths are 776 mm, 1026 mm, 1266 mm and 1526 mm. The system Drawer widths are 324 mm, 466 mm and 609 mm.

Drawer heights vary from 176 mm until 579 mm. In the following sequence: 176 mm, 310 mm 445 mm and 579 mm.

All XLD Drawers come with 3 dividers and mounting blocks included.

Drawer slides are included.

4 lengths
L1/L2/L3/L4

4 heights
HL1/HL2/HL2/H2

3 widths
W1/W2/W3

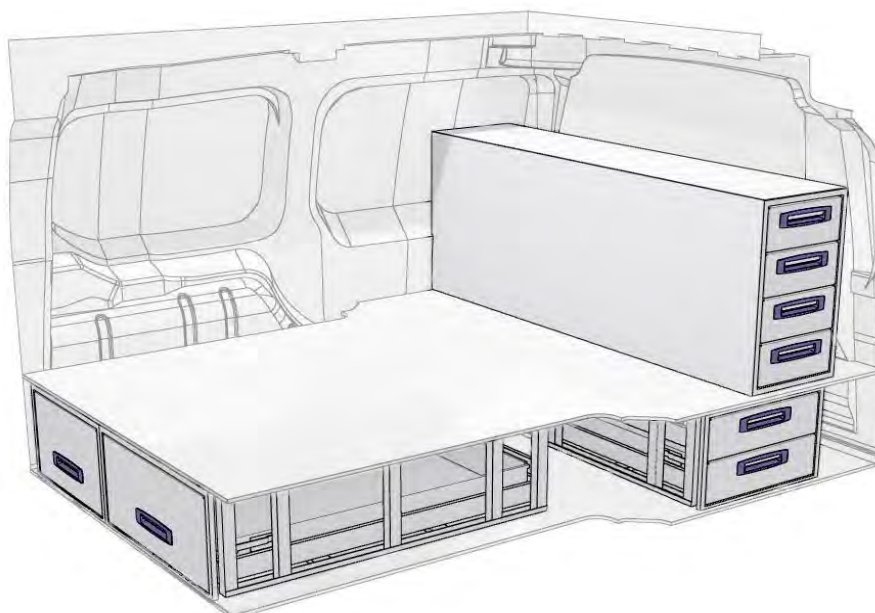
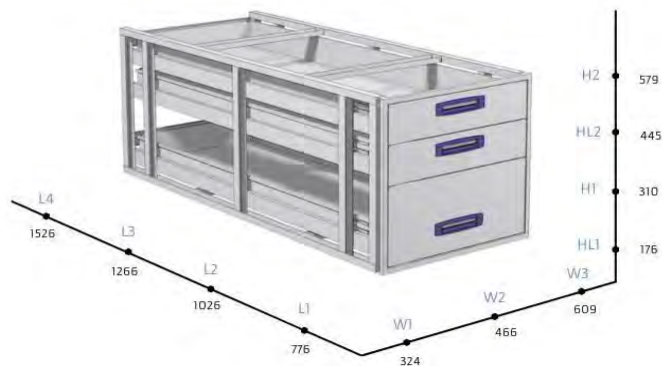

XLD hybrid drawers opening 100%.



Height - 176 mm

XLD drawers are in 4 system depths of 776 mm, 1026 mm, 1266 mm, 1526 mm and three widths: 324 mm, 466 mm and 609 mm.

3 dividers included.

Slides are included!

EAN	ARTICLE	System Dimensions	Internal Dimensions	Weight / kg
		Height x Width x Depth	Height x Width x Depth	
16-0-088-00	XLD-L1W1HL1-1	176 x 324 x 776	104 x 208 x 720	14,8
16-0-079-00	XLD-L2W1HL1-1	176 x 324 x 1026	104 x 208 x 970	16,8
16-0-070-00	XLD-L3W1HL1-1	176 x 324 x 1266	104 x 208 x 1210	19,0
16-0-061-00	XLD-L4W1HL1-1	176 x 324 x 1526	104 x 208 x 1470	21,7
16-0-089-00	XLD-L1W2HL1-1	176 x 466 x 776	104 x 350 x 720	15,8
16-0-080-00	XLD-L2W2HL1-1	176 x 466 x 1026	104 x 350 x 970	20,0
16-0-071-00	XLD-L3W2HL1-1	176 x 466 x 1266	104 x 350 x 1210	21,0
16-0-062-00	XLD-L4W2HL1-1	176 x 466 x 1526	104 x 350 x 1470	23,8
16-0-090-00	XLD-L1W3HL1-1	176 x 609 x 776	104 x 493 x 720	17,8
16-0-081-00	XLD-L2W3HL1-1	176 x 609 x 1026	104 x 493 x 970	20,7
16-0-072-00	XLD-L3W3HL1-1	176 x 609 x 1266	104 x 493 x 1210	23,1
16-0-063-00	XLD-L4W3HL1-1	176 x 609 x 1526	104 x 493 x 1470	25,9

* Divided flat surface load 80 kgs

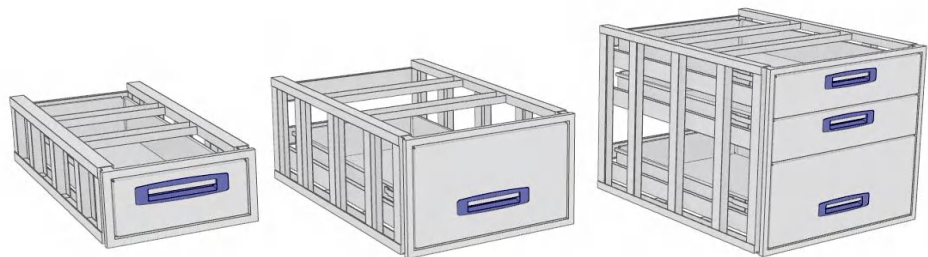

Additional dividers.

Dividers per piece with 4 mounting blocks.

16-0-325-00	DW1	100 x 324 x 1		0,1
16-0-326-00	DW2	100 x 466 x 1		0,1
16-0-327-00	DW3	100 x 609 x 1		0,1



Side covers.

Additional equipment.

If required, please order it separately.

16-0-331-00	XLD-L1HL1-SC	176 x 1 x 776		0,3
16-0-335-00	XLD-L2HL1-SC	176 x 1 x 1026		0,5
16-0-339-00	XLD-L3HL1-SC	176 x 1 x 1266		0,6
16-0-343-00	XLD-L4HL1-SC	176 x 1 x 1526		0,7



Top covers.

Additional equipment.

If required, please order it separately.

EAN	ARTICLE	System Dimensions	
		Height x Width x Depth	Weight / kg
16-0-347-00	XLD-L1W1-TC	1 x 324 x 776	0,7
16-0-348-00	XLD-L1W2-TC	1 x 466 x 776	1
16-0-349-00	XLD-L1W3-TC	1 x 609 x 776	1,3
16-0-350-00	XLD-L2W1-TC	1 x 324 x 1026	0,9
16-0-351-00	XLD-L2W2-TC	1 x 466 x 1026	1,2
16-0-352-00	XLD-L2W3-TC	1 x 609 x 1026	1,7
16-0-353-00	XLD-L3W1-TC	1 x 324 x 1266	1,1
16-0-354-00	XLD-L3W2-TC	1 x 466 x 1266	1,6
16-0-355-00	XLD-L3W3-TC	1 x 609 x 1266	2,0
16-0-356-00	XLD-L4W1-TC	1 x 324 x 1526	1,3
16-0-357-00	XLD-L4W2-TC	1 x 466 x 1526	1,9
16-0-358-00	XLD-L4W3-TC	1 x 609 x 1526	2,5

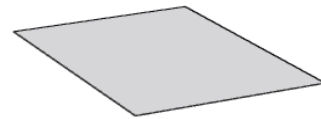

Back covers.

Additional equipment.

If required, please order it separately.

16-0-359-00	XLD-W1HL1-BC	176 x 324 x 1	0,2
16-0-363-00	XLD-W2HL1-BC	176 x 466 x 1	0,3
16-0-367-00	XLD-W3HL1-BC	176 x 609 x 1	0,3

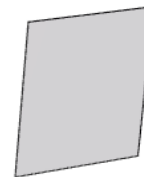

Top edge.

Additional equipment.

If required, please order it separately.

16-0-313-00	1EL1W1	120 x 324 x 776	0,72
16-0-314-00	1EL1W2	120 x 466 x 776	0,8
16-0-315-00	1EL1W3	120 x 609 x 776	0,85
16-0-316-00	1EL2W1	120 x 324 x 1026	0,93
16-0-317-00	1EL2W2	120 x 466 x 1026	0,99
16-0-318-00	1EL2W3	120 x 609 x 1026	1,1
16-0-319-00	1EL3W1	120 x 324 x 1266	1,3
16-0-320-00	1EL3W2	120 x 466 x 1266	1,2
16-0-321-00	1EL3W3	120 x 609 x 1266	1,3
16-0-322-00	1EL4W1	120 x 324 x 1526	1,4
16-0-323-00	1EL4W2	120 x 466 x 1526	1,4
16-0-324-00	1EL4W3	120 x 609 x 1526	1,5

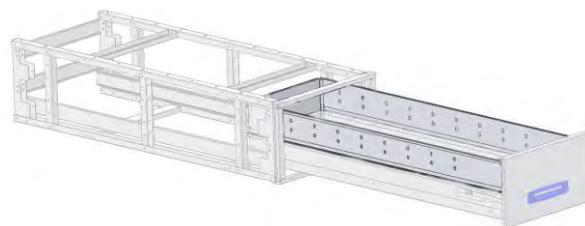
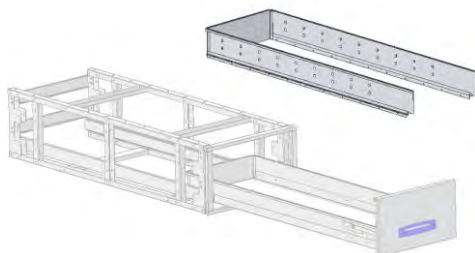

XLD hybrid drawers opening 100%.



Height - 310 mm

XLD drawers are in 4 system depths of 776 mm, 1026 mm, 1266 mm, 1526 mm and three widths: 324 mm, 466 mm and 609 mm.

3 low dividers included.

Slides are included!

XLD-L1W1H1-1 with one drawer, XLD-L1W1H1-2 with two drawers. The number at the end of the article name indicates the number of drawers.

EAN	ARTICLE	System Dimensions		Weight / kg
		Height x Width x Depth	Internal Dimensions	
16-0-010-00	XLD-L1W1H1-1	310 x 324 x 776	104 x 208 x 720	17,2
16-0-011-00	XLD-L1W1H1-2	310 x 324 x 776	104 x 208 x 720	22,7
16-0-005-00	XLD-L2W1H1-1	310 x 324 x 1026	104 x 208 x 970	23,4
16-0-006-00	XLD-L2W1H1-2	310 x 324 x 1026	104 x 208 x 970	29,5
16-0-003-00	XLD-L3W1H1-1	310 x 324 x 1266	104 x 208 x 1210	25,3
16-0-004-00	XLD-L3W1H1-2	310 x 324 x 1266	104 x 208 x 1210	31,0
16-0-001-00	XLD-L4W1H1-1	310 x 324 x 1526	104 x 208 x 1470	27,0
16-0-002-00	XLD-L4W1H1-2	310 x 324 x 1526	104 x 208 x 1470	35,3

16-0-024-00	XLD-L1W2H1-1	310 x 466 x 776	104 x 350 x 720	20,9
16-0-025-00	XLD-L1W2H1-2	310 x 466 x 776	104 x 350 x 720	28,1
16-0-019-00	XLD-L2W2H1-1	310 x 466 x 1026	104 x 350 x 970	23,1
16-0-020-00	XLD-L2W2H1-2	310 x 466 x 1026	104 x 350 x 970	34,0
16-0-017-00	XLD-L3W2H1-1	310 x 466 x 1266	104 x 350 x 1210	27,2
16-0-018-00	XLD-L3W2H1-2	310 x 466 x 1266	104 x 350 x 1210	38,7
16-0-015-00	XLD-L4W2H1-1	310 x 466 x 1526	104 x 350 x 1470	32,0
16-0-016-00	XLD-L4W2H1-2	310 x 466 x 1526	104 x 350 x 1470	38,8

16-0-038-00	XLD-L1W3H1-1	310 x 609 x 776	104 x 493 x 720	23,3
16-0-039-00	XLD-L1W3H1-2	310 x 609 x 776	104 x 493 x 720	28,4
16-0-033-00	XLD-L2W3H1-1	310 x 609 x 1026	104 x 493 x 970	24,9
16-0-034-00	XLD-L2W3H1-2	310 x 609 x 1026	104 x 493 x 970	37,4
16-0-031-00	XLD-L3W3H1-1	310 x 609 x 1266	104 x 493 x 1210	27,2
16-0-032-00	XLD-L3W3H1-2	310 x 609 x 1266	104 x 493 x 1210	42,4
16-0-029-00	XLD-L4W3H1-1	310 x 609 x 1526	104 x 493 x 1470	33,0
16-0-030-00	XLD-L4W3H1-2	310 x 609 x 1526	104 x 493 x 1470	42,7

* Divided flat surface load 80 kgs



Additional dividers.

Dividers per piece with 4 mounting blocks.

There are 2 heights of dividers: DW (low) and DWH (high). DWH can be mounted only when there is an upper section mounted.

16-0-325-00	DW1	100 x 324 x 1	standard	0,1
16-0-326-00	DW2	100 x 466 x 1	standard	0,1
16-0-327-00	DW3	100 x 609 x 1	standard	0,1

16-0-328-00	DWH1	210 x 324 x 1	option	0,1
16-0-329-00	DWH2	210 x 466 x 1	option	0,1
16-0-330-00	DWH3	210 x 609 x 1	option	0,1



Side covers.

Additional equipment.

If required, please order it separately.

EAN	ARTICLE	System Dimensions Height x Width x Depth	Weight / kg
16-0-332-00	XLD-L1H1-SC	310 x 1 x 776	0,6
16-0-336-00	XLD-L2H1-SC	310 x 1 x 1026	0,8
16-0-340-00	XLD-L3H1-SC	310 x 1 x 1266	1,0
16-0-344-00	XLD-L4H1-SC	310 x 1 x 1526	1,3

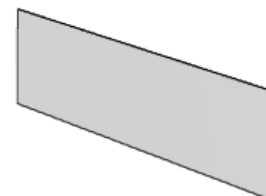

Top covers.

Additional equipment.

If required, please order it separately.

16-0-347-00	XLD-L1W1-TC	1 x 324 x 776	0,7
16-0-348-00	XLD-L1W2-TC	1 x 466 x 776	1
16-0-349-00	XLD-L1W3-TC	1 x 609 x 776	1,3

16-0-350-00	XLD-L2W1-TC	1 x 324 x 1026	0,9
16-0-351-00	XLD-L2W2-TC	1 x 466 x 1026	1,2
16-0-352-00	XLD-L2W3-TC	1 x 609 x 1026	1,7

16-0-353-00	XLD-L3W1-TC	1 x 324 x 1266	1,1
16-0-354-00	XLD-L3W2-TC	1 x 466 x 1266	1,6
16-0-355-00	XLD-L3W3-TC	1 x 609 x 1266	2,0

16-0-356-00	XLD-L4W1-TC	1 x 324 x 1526	1,3
16-0-357-00	XLD-L4W2-TC	1 x 466 x 1526	1,9
16-0-358-00	XLD-L4W3-TC	1 x 609 x 1526	2,5

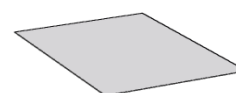

Back covers.

Additional equipment.

If required, please order it separately.

16-0-360-00	XLD-W1H1-BC	310 x 324 x 1	0,3
16-0-364-00	XLD-W2H1-BC	310 x 466 x 1	0,4
16-0-368-00	XLD-W3H1-BC	310 x 609 x 1	0,6

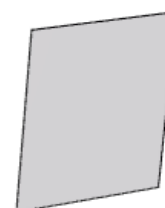

XLD hybrid drawers opening 100%.



Top edge.

Additional equipment.

If required, please order it separately.

EAN	ARTICLE	System Dimensions Height x Width x Depth	Weight / kg
16-0-313-00	TEL1W1	120 x 324 x 776	0,72
16-0-314-00	TEL1W2	120 x 466 x 776	0,8
16-0-315-00	TEL1W3	120 x 609 x 776	0,85
16-0-316-00	TEL2W1	120 x 324 x 1026	0,93
16-0-317-00	TEL2W2	120 x 466 x 1026	0,99
16-0-318-00	TEL2W3	120 x 609 x 1026	1,1
16-0-319-00	TEL3W1	120 x 324 x 1266	1,3
16-0-320-00	TEL3W2	120 x 466 x 1266	1,2
16-0-321-00	TEL3W3	120 x 609 x 1266	1,3
16-0-322-00	TEL4W1	120 x 324 x 1526	1,4
16-0-323-00	TEL4W2	120 x 466 x 1526	1,4
16-0-324-00	TEL4W3	120 x 609 x 1526	1,5

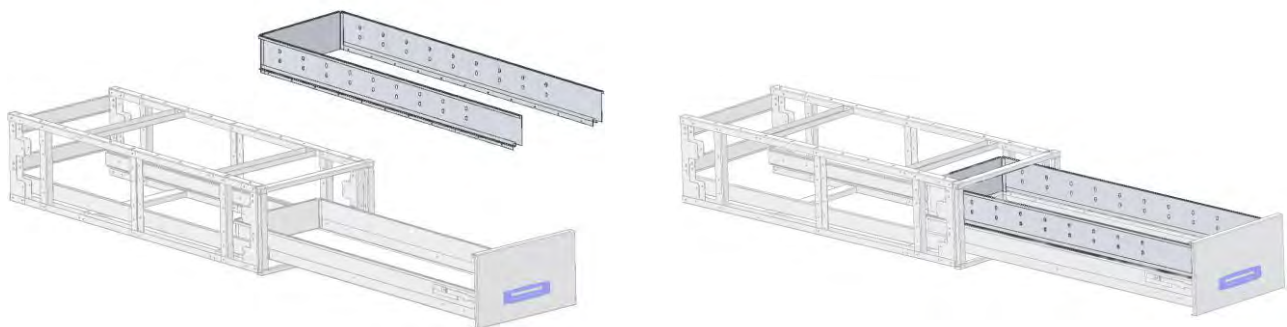

Height - 445 mm

XLD drawers are in 4 system depths of 776 mm, 1026 mm, 1266 mm, 1526 mm and three widths: 324 mm, 466 mm and 609 mm and three widths: 324 mm, 466 mm and 609 mm.

3 low dividers included.

Slides are included!

XLD-L1W1HL2-2 with two drawer, XLD-L1W1HL2-3 with three drawers. The number at the end of the article name indicates the number of drawers.

EAN	ARTICLE	System Dimensions		Internal Dimensions		Weight / kg
		Height x Width x Depth		Height x Width x Depth		
16-0-091-00	XLD-L1W1HL2-2	445 x 324 x 776		104 x 208 x 720		25,7
16-0-092-00	XLD-L1W1HL2-3	445 x 324 x 776		104 x 208 x 720		31,2
16-0-082-00	XLD-L2W1HL2-2	445 x 324 x 1026		104 x 208 x 970		30,5
16-0-083-00	XLD-L2W1HL2-3	445 x 324 x 1026		104 x 208 x 970		37,9
16-0-073-00	XLD-L3W1HL2-2	445 x 324 x 1266		104 x 208 x 1210		34,0
16-0-074-00	XLD-L3W1HL2-3	445 x 324 x 1266		104 x 208 x 1210		42,7
16-0-064-00	XLD-L4W1HL2-2	445 x 324 x 1526		104 x 208 x 1470		38,3
16-0-065-00	XLD-L4W1HL2-3	445 x 324 x 1526		104 x 208 x 1470		48,7

16-0-093-00	XLD-L1W2HL2-2	445 x 466 x 776		104 x 350 x 720		28,9
16-0-094-00	XLD-L1W2HL2-3	445 x 466 x 776		104 x 350 x 720		35,1
16-0-084-00	XLD-L2W2HL2-2	445 x 466 x 1026		104 x 350 x 970		33,9
16-0-085-00	XLD-L2W2HL2-3	445 x 466 x 1026		104 x 350 x 970		42,1
16-0-075-00	XLD-L3W2HL2-2	445 x 466 x 1266		104 x 350 x 1210		40,4
16-0-076-00	XLD-L3W2HL2-3	445 x 466 x 1266		104 x 350 x 1210		47,3
16-0-066-00	XLD-L4W2HL2-2	445 x 466 x 1526		104 x 350 x 1470		42,1
16-0-067-00	XLD-L4W2HL2-3	445 x 466 x 1526		104 x 350 x 1470		53,5

16-0-095-00	XLD-L1W3HL2-2	445 x 609 x 776		104 x 493 x 720		32,0
16-0-096-00	XLD-L1W3HL2-3	445 x 609 x 776		104 x 493 x 720		38,7
16-0-086-00	XLD-L2W3HL2-2	445 x 609 x 1026		104 x 493 x 970		37,4
16-0-087-00	XLD-L2W3HL2-3	445 x 609 x 1026		104 x 493 x 970		46,3
16-0-077-00	XLD-L3W3HL2-2	445 x 609 x 1266		104 x 493 x 1210		41,3
16-0-078-00	XLD-L3W3HL2-3	445 x 609 x 1266		104 x 493 x 1210		51,7
16-0-068-00	XLD-L4W3HL2-2	445 x 609 x 1526		104 x 493 x 1470		45,9
16-0-069-00	XLD-L4W3HL2-3	445 x 609 x 1526		104 x 493 x 1470		58,2

* Divided flat surface load 80 kgs

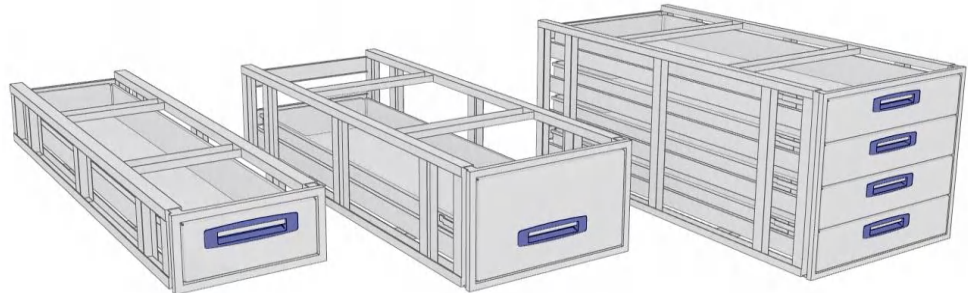

Additional dividers.

Dividers per piece with 4 mounting blocks.

There are 2 heights of dividers: DW (low) and DWH (high). DWH can be mounted only when there is an upper section mounted.

16-0-325-00	DW1	100 x 324 x 1	standard	0,1
16-0-326-00	DW2	100 x 466 x 1	standard	0,1
16-0-327-00	DW3	100 x 609 x 1	standard	0,1

16-0-328-00	DWH1	210 x 324 x 1	option	0,1
16-0-329-00	DWH2	210 x 466 x 1	option	0,1
16-0-330-00	DWH3	210 x 609 x 1	option	0,1



Side covers.

Additional equipment.

If required, please order it separately.

EAN	ARTICLE	System Dimensions	Weight / kg
		Height x Width x Depth	
16-0-333-00	XLD-L1HL2-SC	445 x 1 x 776	0,9
16-0-337-00	XLD-L2HL2-SC	445 x 1 x 1026	1,2
16-0-341-00	XLD-L3HL2-SC	445 x 1 x 1266	1,5
16-0-345-00	XLD-L4HL2-SC	445 x 1 x 1526	1,8



Top covers.

Additional equipment.

If required, please order it separately.

16-0-347-00	XLD-L1W1-TC	1 x 324 x 776	0,7
16-0-348-00	XLD-L1W2-TC	1 x 466 x 776	1
16-0-349-00	XLD-L1W3-TC	1 x 609 x 776	1,3

16-0-350-00	XLD-L2W1-TC	1 x 324 x 1026	0,9
16-0-351-00	XLD-L2W2-TC	1 x 466 x 1026	1,2
16-0-352-00	XLD-L2W3-TC	1 x 609 x 1026	1,7

16-0-353-00	XLD-L3W1-TC	1 x 324 x 1266	1,1
16-0-354-00	XLD-L3W2-TC	1 x 466 x 1266	1,6
16-0-355-00	XLD-L3W3-TC	1 x 609 x 1266	2,0

16-0-356-00	XLD-L4W1-TC	1 x 324 x 1526	1,3
16-0-357-00	XLD-L4W2-TC	1 x 466 x 1526	1,9
16-0-358-00	XLD-L4W3-TC	1 x 609 x 1526	2,5

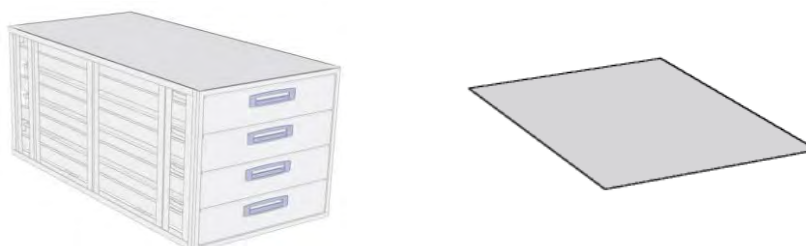

Back covers.

Additional equipment.

If required, please order it separately.

16-0-361-00	XLD-W1HL2-BC	445 x 324 x 1	0,4
16-0-365-00	XLD-W2HL2-BC	445 x 466 x 1	0,6
16-0-369-00	XLD-W3HL2-BC	445 x 609 x 1	0,8



XLD hybrid drawers opening 100%.



Top edge.

Additional equipment.

If required, please order it separately.

EAN	ARTICLE	System Dimensions Height x Width x Depth	Weight / kg
16-0-313-00	TEL1W1	120 x 324 x 776	0,72
16-0-314-00	TEL1W2	120 x 466 x 776	0,8
16-0-315-00	TEL1W3	120 x 609 x 776	0,85
16-0-316-00	TEL2W1	120 x 324 x 1026	0,93
16-0-317-00	TEL2W2	120 x 466 x 1026	0,99
16-0-318-00	TEL2W3	120 x 609 x 1026	1,1
16-0-319-00	TEL3W1	120 x 324 x 1266	1,3
16-0-320-00	TEL3W2	120 x 466 x 1266	1,2
16-0-321-00	TEL3W3	120 x 609 x 1266	1,3
16-0-322-00	TEL4W1	120 x 324 x 1526	1,4
16-0-323-00	TEL4W2	120 x 466 x 1526	1,4
16-0-324-00	TEL4W3	120 x 609 x 1526	1,5

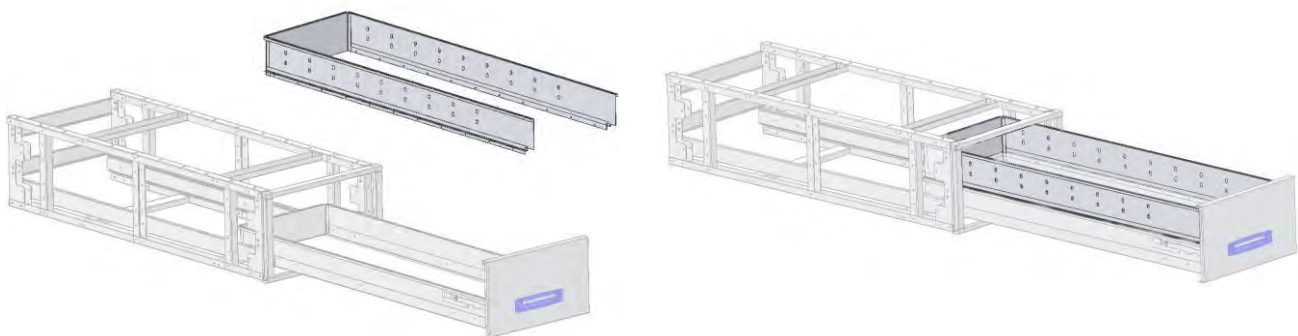

XLD hybrid drawers opening 100%.



Height - 579 mm

XLD drawers are in 4 system depths of 776 mm, 1026 mm, 1266 mm, 1526 mm and three widths: 324 mm, 466 mm and 609 mm.

3 low dividers included. Slides are included!

XLD-L1W1H2-2 with two drawer, XLD-L1W1H2-3 with three drawers, XLD-L1W1H2-4 with 4 drawers. The number at the end of the article name indicates the number of "working" drawers.

EAN	ARTICLE	System Dimensions		Internal Dimensions		Weight / kg
		Height x Width x Depth		Height x Width x Depth		
16-0-012-00	XLD-L1W1H2-2	579	324 x 776	104	208 x 720	28,7
16-0-013-00	XLD-L1W1H2-3	579	324 x 776	104	208 x 720	34,2
16-0-014-00	XLD-L1W1H2-4	579	324 x 776	104	208 x 720	39,6
16-0-007-00	XLD-L2W1H2-2	579	324 x 1026	104	208 x 970	36,5
16-0-008-00	XLD-L2W1H2-3	579	324 x 1026	104	208 x 970	40,8
16-0-009-00	XLD-L2W1H2-4	579	324 x 1026	104	208 x 970	48,3
16-0-051-00	XLD-L3W1H2-2	579	324 x 1266	104	208 x 1210	37,0
16-0-052-00	XLD-L3W1H2-3	579	324 x 1266	104	208 x 1210	50,2
16-0-053-00	XLD-L3W1H2-4	579	324 x 1266	104	208 x 1210	54,5
16-0-060-00	XLD-L4W1H2-2	579	324 x 1526	104	208 x 1470	41,3
16-0-043-00	XLD-L4W1H2-3	579	324 x 1526	104	208 x 1470	51,7
16-0-044-00	XLD-L4W1H2-4	579	324 x 1526	104	208 x 1470	62,1

16-0-026-00	XLD-L1W2H2-2	579	466 x 776	104	350 x 720	32,4
16-0-027-00	XLD-L1W2H2-3	579	466 x 776	104	350 x 720	42,0
16-0-028-00	XLD-L1W2H2-4	579	466 x 776	104	350 x 720	49,6
16-0-021-00	XLD-L2W2H2-2	579	466 x 1026	104	350 x 970	37,2
16-0-022-00	XLD-L2W2H2-3	579	466 x 1026	104	350 x 970	54,7
16-0-023-00	XLD-L2W2H2-4	579	466 x 1026	104	350 x 970	49,0
16-0-054-00	XLD-L3W2H2-2	579	466 x 1266	104	350 x 1210	41,0
16-0-055-00	XLD-L3W2H2-3	579	466 x 1266	104	350 x 1210	55,2
16-0-056-00	XLD-L3W2H2-4	579	466 x 1266	104	350 x 1210	60,2
16-0-045-00	XLD-L4W2H2-2	579	466 x 1526	104	350 x 1470	45,4
16-0-046-00	XLD-L4W2H2-3	579	466 x 1526	104	350 x 1470	56,8
16-0-047-00	XLD-L4W2H2-4	579	466 x 1526	104	350 x 1470	68,1

16-0-040-00	XLD-L1W3H2-2	579	609 x 776	104	493 x 720	35,6
16-0-041-00	XLD-L1W3H2-3	579	609 x 776	104	493 x 720	42,3
16-0-042-00	XLD-L1W3H2-4	579	609 x 776	104	493 x 720	49,0
16-0-035-00	XLD-L2W3H2-2	579	609 x 1026	104	493 x 970	41,0
16-0-036-00	XLD-L2W3H2-3	579	609 x 1026	104	493 x 970	53,9
16-0-037-00	XLD-L2W3H2-4	579	609 x 1026	104	493 x 970	58,8
16-0-057-00	XLD-L3W3H2-2	579	609 x 1266	104	493 x 1210	44,9
16-0-058-00	XLD-L3W3H2-3	579	609 x 1266	104	493 x 1210	55,3
16-0-059-00	XLD-L3W3H2-4	579	609 x 1266	104	493 x 1210	65,8
16-0-048-00	XLD-L4W3H2-2	579	609 x 1526	104	493 x 1470	46,1
16-0-049-00	XLD-L4W3H2-3	579	609 x 1526	104	493 x 1470	43,0
16-0-050-00	XLD-L4W3H2-4	579	609 x 1526	104	493 x 1470	74,1

* Divided flat surface load 80 kgs

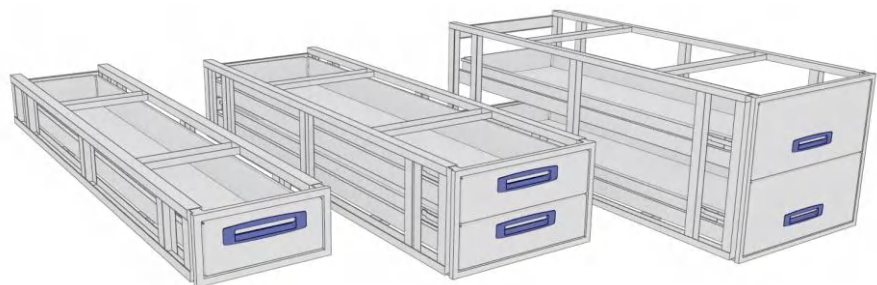

Additional dividers.

Dividers per piece with 4 mounting blocks.

There are 2 heights of dividers: DW (low) and DWH (high). DWH can be mounted only when there is an upper section mounted.

16-0-325-00	DW1	100 x 324 x 1	standard	0,1
16-0-326-00	DW2	100 x 466 x 1	standard	0,1
16-0-327-00	DW3	100 x 609 x 1	standard	0,1

16-0-328-00	DWH1	210 x 324 x 1	option	0,1
16-0-329-00	DWH2	210 x 466 x 1	option	0,1
16-0-330-00	DWH3	210 x 609 x 1	option	0,1



Side covers.

Additional equipment.

If required, please order it separately.

EAN	ARTICLE	System Dimensions Height x Width x Depth	Weight / kg
16-0-334-00	XLD-L1H2-SC	579 x 1 x 776	0,6
16-0-338-00	XLD-L2H2-SC	579 x 1 x 1026	1,6
16-0-342-00	XLD-L3H2-SC	579 x 1 x 1266	2,0
16-0-346-00	XLD-L4H2-S.C.	579 x 1 x 1526	2,4

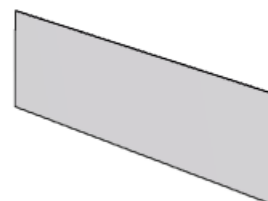

Top covers.

Additional equipment.

If required, please order it separately.

16-0-347-00	XLD-L1W1-TC	1 x 324 x 776	0,7
16-0-348-00	XLD-L1W2-TC	1 x 466 x 776	1
16-0-349-00	XLD-L1W3-TC	1 x 609 x 776	1,3

16-0-350-00	XLD-L2W1-TC	1 x 324 x 1026	0,9
16-0-351-00	XLD-L2W2-TC	1 x 466 x 1026	1,2
16-0-352-00	XLD-L2W3-TC	1 x 609 x 1026	1,7

16-0-353-00	XLD-L3W1-TC	1 x 324 x 1266	1,1
16-0-354-00	XLD-L3W2-TC	1 x 466 x 1266	1,6
16-0-355-00	XLD-L3W3-TC	1 x 609 x 1266	2,0

16-0-356-00	XLD-L4W1-TC	1 x 324 x 1526	1,3
16-0-357-00	XLD-L4W2-TC	1 x 466 x 1526	1,9
16-0-358-00	XLD-L4W3-TC	1 x 609 x 1526	2,5

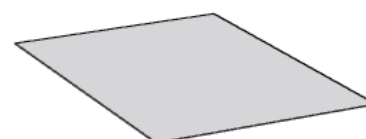

Back covers.

Additional equipment.

If required, please order it separately.

16-0-362-00	XLD-W1H2-BC	579 x 324 x 1	0,6
16-0-366-00	XLD-W2H2-BC	579 x 466 x 1	0,8
16-0-370-00	XLD-W3H2-BC	579 x 609 x 1	1,0

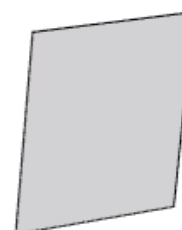

XLD hybrid drawers opening 100%.



Top edge.

Additional equipment.

If required, please order it separately.

EAN	ARTICLE	System Dimensions Height x Width x Depth	Weight / kg
16-0-313-00	TEL1W1	120 x 324 x 776	0,72
16-0-314-00	TEL1W2	120 x 466 x 776	0,8
16-0-315-00	TEL1W3	120 x 609 x 776	0,85
16-0-316-00	TEL2W1	120 x 324 x 1026	0,93
16-0-317-00	TEL2W2	120 x 466 x 1026	0,99
16-0-318-00	TEL2W3	120 x 609 x 1026	1,1
16-0-319-00	TEL3W1	120 x 324 x 1266	1,3
16-0-320-00	TEL3W2	120 x 466 x 1266	1,2
16-0-321-00	TEL3W3	120 x 609 x 1266	1,3
16-0-322-00	TEL4W1	120 x 324 x 1526	1,4
16-0-323-00	TEL4W2	120 x 466 x 1526	1,4
16-0-324-00	TEL4W3	120 x 609 x 1526	1,5

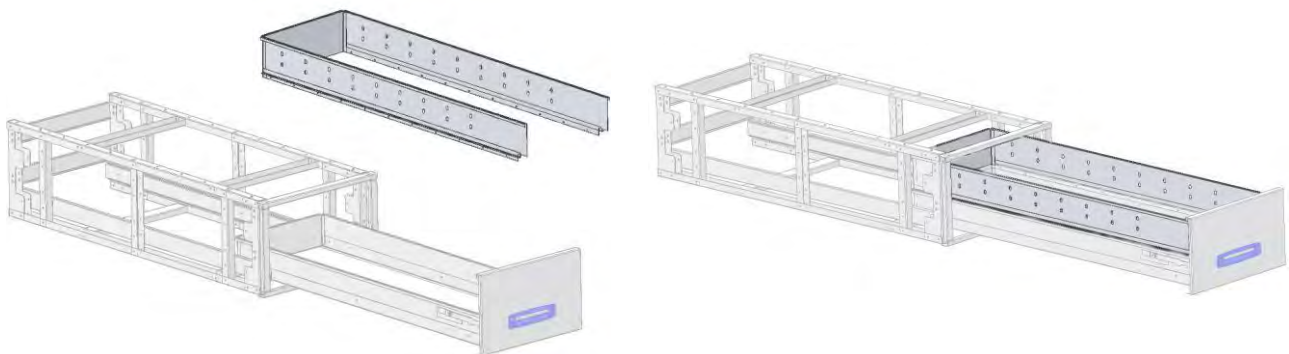



Uw dealer :